

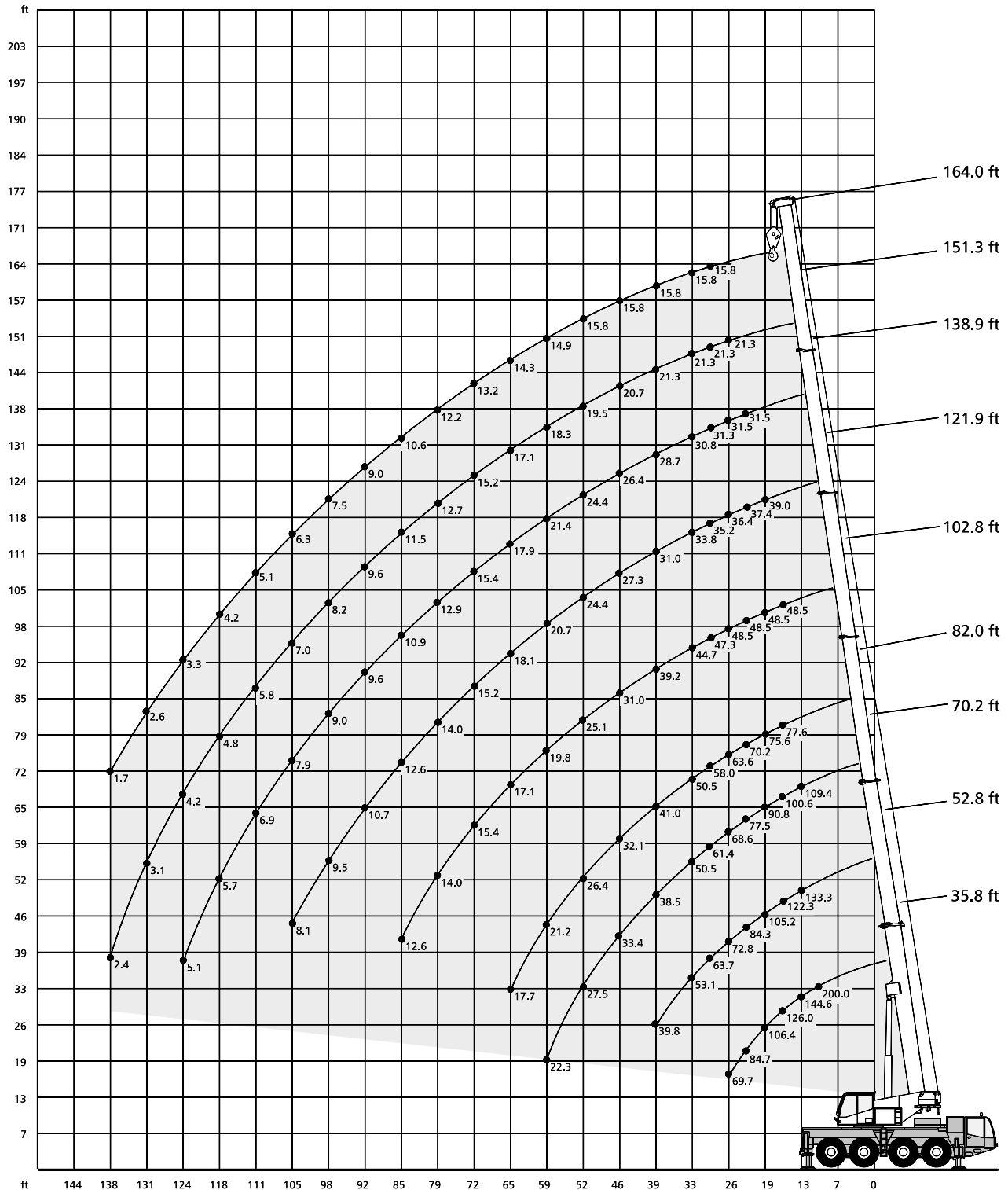

LIFTING CHARTS - All Terrain Cranes



DEMAG MODEL AC 80-2 - 100 TON CAPACITY



Working ranges main boom



STERLING CRANE

Lifting capacities main boom





| 39,700 lb | |  25'3" x 23' 360° | | | | | | | | | 0°* | | 85 % | |
|-----------|--------|--|-------|------|------|-------|-------|-------|-------|-------|---|------|--------|-----|
| | | Length of main boom | | | | | | | | |  | | | |
| Radius | ft | 35.8 | 52.8 | 70.2 | 82.0 | 102.8 | 121.9 | 138.9 | 151.3 | 164.0 | 35.8 | 52.8 | Radius | ft |
| | | 1,000 lb | | | | | | | | | 1,000 lb | | | |
| 10 | 200.0* | - | - | - | - | - | - | - | - | - | - | - | 10 | 10 |
| 10 | 168.4 | - | - | - | - | - | - | - | - | - | - | - | 10 | 10 |
| 11 | 160.1 | 133.3 | - | - | - | - | - | - | - | - | - | - | 11 | 11 |
| 13 | 144.6 | 133.3 | 109.4 | - | - | - | - | - | - | - | - | - | 13 | 13 |
| 15 | 131.7 | 127.1 | 103.5 | 77.6 | - | - | - | - | - | - | - | - | 15 | 15 |
| 16 | 126.0 | 122.3 | 100.6 | 77.6 | 48.5 | - | - | - | - | - | - | - | 16 | 16 |
| 19 | 106.4 | 105.2 | 90.8 | 75.6 | 48.5 | 39.0 | - | - | - | - | - | - | 19 | 19 |
| 23 | 84.7 | 84.3 | 77.5 | 70.2 | 48.5 | 37.4 | 31.5 | - | - | - | - | - | 23 | 23 |
| 26 | 69.7 | 72.8 | 68.6 | 63.6 | 48.5 | 36.4 | 31.5 | 21.3 | - | - | - | - | 26 | 26 |
| 29 | - | 63.7 | 61.4 | 58.0 | 47.3 | 35.2 | 31.3 | 21.3 | 15.8 | - | - | - | 29 | 29 |
| 33 | - | 53.1 | 50.5 | 50.5 | 44.7 | 33.8 | 30.8 | 21.3 | 15.8 | - | - | - | 33 | 33 |
| 39 | - | 39.8 | 38.5 | 41.0 | 39.2 | 31.0 | 28.7 | 21.3 | 15.8 | - | - | - | 39 | 39 |
| 46 | - | - | 33.4 | 32.1 | 31.0 | 27.3 | 26.4 | 20.7 | 15.8 | - | - | - | 46 | 46 |
| 52 | - | - | 27.5 | 26.4 | 25.1 | 24.4 | 24.4 | 19.5 | 15.8 | - | - | - | 52 | 52 |
| 59 | - | - | 22.3 | 21.2 | 19.8 | 20.7 | 21.4 | 18.3 | 14.9 | - | - | - | 59 | 59 |
| 65 | - | - | - | 17.7 | 17.1 | 18.1 | 17.9 | 17.1 | 14.3 | - | - | - | 65 | 65 |
| 72 | - | - | - | - | 15.4 | 15.2 | 15.4 | 15.2 | 13.2 | - | - | - | 72 | 72 |
| 79 | - | - | - | - | 14.0 | 14.0 | 12.9 | 12.7 | 12.2 | - | - | - | 79 | 79 |
| 85 | - | - | - | - | 12.6 | 12.6 | 10.9 | 11.5 | 10.6 | - | - | - | 85 | 85 |
| 92 | - | - | - | - | - | 10.7 | 9.6 | 9.6 | 9.0 | - | - | - | 92 | 92 |
| 98 | - | - | - | - | - | 9.5 | 9.0 | 8.2 | 7.5 | - | - | - | 98 | 98 |
| 105 | - | - | - | - | - | 8.1 | 7.9 | 7.0 | 6.3 | - | - | - | 105 | 105 |
| 111 | - | - | - | - | - | - | 6.9 | 5.8 | 5.1 | - | - | - | 111 | 111 |
| 118 | - | - | - | - | - | - | - | 5.7 | 4.8 | 4.2 | - | - | 118 | 118 |
| 124 | - | - | - | - | - | - | - | 5.1 | 4.2 | 3.3 | - | - | 124 | 124 |
| 131 | - | - | - | - | - | - | - | - | 3.1 | 2.6 | - | - | 131 | 131 |
| 138 | - | - | - | - | - | - | - | - | 2.4 | 1.7 | - | - | 138 | 138 |

| 17,600 lb | |  25'3" x 23' 360° | | | | | | | | | 0°* | | 85 % | |
|-----------|--------|--|-------|------|------|-------|-------|-------|-------|-------|---|------|--------|-----|
| | | Length of main boom | | | | | | | | |  | | | |
| Radius | ft | 35.8 | 52.8 | 70.2 | 82.0 | 102.8 | 121.9 | 138.9 | 151.3 | 164.0 | 35.8 | 52.8 | Radius | ft |
| | | 1,000 lb | | | | | | | | | 1,000 lb | | | |
| 10 | 200.0* | - | - | - | - | - | - | - | - | - | - | - | 10 | 10 |
| 10 | 168.3 | - | - | - | - | - | - | - | - | - | - | - | 10 | 10 |
| 11 | 159.6 | 133.3 | - | - | - | - | - | - | - | - | - | - | 11 | 11 |
| 13 | 144.0 | 133.3 | 109.4 | - | - | - | - | - | - | - | - | - | 13 | 13 |
| 15 | 126.1 | 125.4 | 103.5 | 77.6 | - | - | - | - | - | - | - | - | 15 | 15 |
| 16 | 117.0 | 116.1 | 100.6 | 77.6 | 48.5 | - | - | - | - | - | - | - | 16 | 16 |
| 19 | 95.8 | 94.9 | 87.7 | 75.6 | 48.5 | 39.0 | - | - | - | - | - | - | 19 | 19 |
| 23 | 75.6 | 74.9 | 66.2 | 62.2 | 48.5 | 37.4 | 31.5 | - | - | - | - | - | 23 | 23 |
| 26 | 59.9 | 58.8 | 54.9 | 51.7 | 48.5 | 36.4 | 31.5 | 21.3 | - | - | - | - | 26 | 26 |
| 29 | - | 47.7 | 44.9 | 46.0 | 44.2 | 35.2 | 31.3 | 21.3 | 15.8 | - | - | - | 29 | 29 |
| 33 | - | 37.1 | 41.5 | 40.4 | 37.2 | 33.7 | 30.7 | 21.3 | 15.8 | - | - | - | 33 | 33 |
| 39 | - | 27.2 | 31.4 | 29.9 | 28.5 | 28.1 | 27.1 | 21.3 | 15.8 | - | - | - | 39 | 39 |
| 46 | - | - | 23.3 | 21.7 | 22.4 | 22.4 | 21.7 | 20.6 | 15.8 | - | - | - | 46 | 46 |
| 52 | - | - | 18.6 | 17.3 | 19.8 | 19.7 | 18.1 | 17.4 | 15.8 | - | - | - | 52 | 52 |
| 59 | - | - | 14.5 | 13.0 | 15.9 | 15.9 | 14.3 | 14.7 | 13.6 | - | - | - | 59 | 59 |
| 65 | - | - | - | 10.4 | 13.2 | 13.0 | 12.4 | 11.9 | 11.0 | - | - | - | 65 | 65 |
| 72 | - | - | - | - | 10.6 | 10.6 | 10.4 | 9.5 | 8.8 | - | - | - | 72 | 72 |
| 79 | - | - | - | - | 8.7 | 8.7 | 8.3 | 7.4 | 6.7 | - | - | - | 79 | 79 |
| 85 | - | - | - | - | 7.3 | 7.1 | 7.1 | 5.8 | 5.1 | - | - | - | 85 | 85 |
| 92 | - | - | - | - | - | 5.7 | 5.4 | 4.6 | 3.9 | - | - | - | 92 | 92 |
| 98 | - | - | - | - | - | 4.7 | 4.6 | 3.3 | 2.9 | - | - | - | 98 | 98 |
| 105 | - | - | - | - | - | 3.9 | 3.5 | 2.6 | 1.9 | - | - | - | 105 | 105 |
| 111 | - | - | - | - | - | - | 2.9 | 1.8 | - | - | - | - | 111 | 111 |
| 118 | - | - | - | - | - | - | 2.2 | - | - | - | - | - | 118 | 118 |
| 124 | - | - | - | - | - | - | 1.6 | - | - | - | - | - | 124 | 124 |

Remarks

* over rear

Lifting capacities main boom

| 11,000 lb | |   25'3" x 23'  360° | | | | | | | | | 0°*  | | 85 % | |
|-----------|-------|--|-------|------|------|-------|-------|-------|-------|-------|--|------|--------|-------|
| | | Length of main boom | | | | | | | | | | | | |
| Radius | ft | 35.8 | 52.8 | 70.2 | 82.0 | 102.8 | 121.9 | 138.9 | 151.3 | 164.0 | 35.8 | 52.8 | Radius | ft |
| | | 1,000 lb | | | | | | | | | 1,000 lb | | | |
| 10 | 168.3 | - | - | - | - | - | - | - | - | - | - | - | 10 | 168.3 |
| 11 | 159.6 | 133.3 | - | - | - | - | - | - | - | - | - | - | 11 | 159.6 |
| 13 | 143.4 | 133.3 | 109.4 | - | - | - | - | - | - | - | 25.5 | 24.8 | 13 | 143.4 |
| 15 | 121.8 | 121.1 | 103.5 | 77.6 | - | - | - | - | - | - | 22.3 | 21.7 | 15 | 121.8 |
| 16 | 112.9 | 112.2 | 100.6 | 77.6 | 48.5 | - | - | - | - | - | 20.8 | 20.3 | 16 | 112.9 |
| 19 | 92.4 | 91.7 | 80.0 | 71.3 | 48.5 | 39.0 | - | - | - | - | 17.3 | 16.7 | 19 | 92.4 |
| 23 | 67.7 | 66.8 | 58.5 | 54.7 | 48.4 | 37.4 | 31.5 | - | - | - | 13.4 | 12.7 | 23 | 67.7 |
| 26 | 53.0 | 52.1 | 48.0 | 46.0 | 45.6 | 36.4 | 31.5 | 21.3 | - | - | 11.2 | 10.5 | 26 | 53.0 |
| 29 | - | 42.2 | 44.0 | 43.8 | 39.3 | 35.0 | 31.3 | 21.3 | 15.8 | - | - | 8.6 | 29 | - |
| 33 | - | 32.5 | 37.1 | 35.8 | 31.9 | 31.1 | 30.2 | 21.3 | 15.8 | - | - | 6.5 | 33 | - |
| 39 | - | 23.0 | 27.2 | 25.7 | 25.7 | 25.0 | 24.0 | 21.3 | 15.8 | - | - | 3.7 | 39 | - |
| 46 | - | - | 19.7 | 18.6 | 21.5 | 21.5 | 18.9 | 17.8 | 15.8 | - | - | - | 46 | - |
| 52 | - | - | 15.7 | 14.4 | 17.3 | 17.1 | 15.2 | 15.1 | 14.0 | - | - | - | 52 | - |
| 59 | - | - | 12.1 | 10.6 | 13.6 | 13.2 | 13.2 | 12.1 | 11.2 | - | - | - | 59 | - |
| 65 | - | - | - | 8.1 | 11.0 | 10.8 | 10.8 | 9.7 | 9.0 | - | - | - | 65 | - |
| 72 | - | - | - | - | 8.8 | 8.4 | 8.4 | 7.3 | 6.6 | - | - | - | 72 | - |
| 79 | - | - | - | - | 6.9 | 6.7 | 6.7 | 5.4 | 4.7 | - | - | - | 79 | - |
| 85 | - | - | - | - | 5.5 | 5.5 | 5.3 | 4.4 | 3.5 | - | - | - | 85 | - |
| 92 | - | - | - | - | - | 4.3 | 4.1 | 3.0 | 2.4 | - | - | - | 92 | - |
| 98 | - | - | - | - | - | 3.3 | 3.1 | 2.2 | 1.6 | - | - | - | 98 | - |
| 105 | - | - | - | - | - | 2.4 | 2.4 | - | - | - | - | - | 105 | - |
| 111 | - | - | - | - | - | - | 1.8 | - | - | - | - | - | 111 | - |
| 118 | - | - | - | - | - | - | - | - | - | - | - | - | 118 | - |

STERLING CRANE

Lifting capacities main boom extension

39,700 lb   **25'3" x 23'** **360°** **85 %**

| 151.3 ft Main boom | | | | | | | | 164.0 ft Main boom | | | | | | | |
|--------------------|-----------|-----|-----|---------|-----|-----|----------|--------------------|-----------|-----|-----|---------|-----|-----|----------|
| Radius ft | Extension | | | | | | 1,000 lb | Radius ft | Extension | | | | | | 1,000 lb |
| | 30.2 ft | | | 57.7 ft | | | | | 30.2 ft | | | 57.7 ft | | | |
| | 0° | 20° | 40° | 0° | 20° | 40° | | | 0° | 20° | 40° | 0° | 20° | 40° | |
| 33 | 9.4 | - | - | - | - | - | 39 | 7.2 | - | - | - | - | - | | |
| 39 | 9.4 | - | - | 4.1 | - | - | 46 | 7.2 | 7.2 | - | 2.8 | - | - | | |
| 46 | 9.4 | 8.1 | - | 4.1 | - | - | 52 | 7.2 | 7.2 | 6.6 | 2.8 | - | - | | |
| 52 | 9.4 | 8.1 | 7.2 | 4.1 | - | - | 59 | 7.2 | 7.0 | 6.6 | 2.8 | - | - | | |
| 59 | 9.4 | 7.9 | 7.2 | 4.1 | 3.3 | - | 65 | 7.0 | 6.8 | 6.4 | 2.8 | 2.6 | - | | |
| 65 | 9.0 | 7.7 | 7.0 | 3.9 | 3.3 | - | 72 | 6.8 | 6.6 | 6.1 | 2.6 | 2.6 | - | | |
| 72 | 8.3 | 7.5 | 6.8 | 3.5 | 3.3 | - | 79 | 6.3 | 6.1 | 5.5 | 2.6 | 2.6 | 2.4 | | |
| 79 | 7.9 | 7.0 | 6.6 | 3.5 | 3.3 | 2.8 | 85 | 6.1 | 5.7 | 5.3 | 2.4 | 2.6 | 2.4 | | |
| 85 | 7.5 | 6.8 | 6.4 | 3.3 | 3.3 | 2.6 | 92 | 5.5 | 5.2 | 5.0 | 2.4 | 2.4 | 2.4 | | |
| 92 | 7.2 | 6.3 | 6.1 | 3.3 | 3.3 | 2.6 | 98 | 5.3 | 5.0 | 4.8 | 2.4 | 2.4 | 2.4 | | |
| 98 | 6.8 | 6.1 | 5.7 | 3.1 | 3.1 | 2.6 | 105 | 5.0 | 4.8 | 4.6 | 2.4 | 2.4 | 2.4 | | |
| 105 | 6.6 | 5.7 | 5.5 | 3.0 | 2.8 | 2.6 | 111 | 4.8 | 4.6 | 4.6 | 2.2 | 2.4 | 2.4 | | |
| 111 | 5.8 | 5.5 | 5.3 | 2.8 | 2.6 | 2.6 | 118 | 4.6 | 4.4 | 4.4 | 2.2 | 2.2 | 2.2 | | |
| 118 | 4.8 | 5.2 | 5.0 | 2.8 | 2.6 | 2.6 | 124 | 3.6 | 4.4 | 4.4 | 2.2 | 2.2 | 2.2 | | |
| 124 | 4.0 | 4.5 | 4.6 | 2.6 | 2.6 | 2.4 | 131 | 2.8 | 3.3 | 3.9 | 1.9 | 2.2 | 2.2 | | |
| 131 | 3.1 | 3.5 | 3.9 | 2.6 | 2.6 | 2.4 | 138 | 2.1 | 2.6 | - | 1.9 | 2.1 | 2.2 | | |
| 138 | 2.4 | 2.8 | - | 2.6 | 2.6 | 2.4 | 144 | 1.7 | 2.2 | - | 1.7 | 1.9 | 2.2 | | |
| 144 | 2.0 | 2.2 | - | 2.4 | 2.6 | 2.4 | 151 | - | 1.5 | - | 1.7 | 1.9 | 1.9 | | |
| 151 | - | 1.5 | - | 1.9 | 2.6 | 2.4 | 157 | - | - | - | - | 1.9 | 1.9 | | |
| 157 | - | - | - | 1.5 | 2.0 | 2.4 | 164 | - | - | - | - | 1.5 | - | | |
| 164 | - | - | - | - | 1.5 | - | 170 | - | - | - | - | - | - | | |

17,600 lb   **25'3" x 23'** **360°** **85 %**

| 151.3 ft Main boom | | | | | | | | 164.0 ft Main boom | | | | | | | |
|--------------------|-----------|-----|-----|---------|-----|-----|----------|--------------------|-----------|-----|-----|---------|-----|-----|----------|
| Radius ft | Extension | | | | | | 1,000 lb | Radius ft | Extension | | | | | | 1,000 lb |
| | 30.2 ft | | | 57.7 ft | | | | | 30.2 ft | | | 57.7 ft | | | |
| | 0° | 20° | 40° | 0° | 20° | 40° | | | 0° | 20° | 40° | 0° | 20° | 40° | |
| 33 | 9.4 | - | - | - | - | - | 39 | 7.2 | - | - | - | - | - | | |
| 39 | 9.4 | - | - | 4.1 | - | - | 46 | 7.2 | 7.2 | - | 2.8 | - | - | | |
| 46 | 9.4 | 8.1 | - | 4.1 | - | - | 52 | 7.2 | 7.2 | 6.6 | 2.8 | - | - | | |
| 52 | 9.4 | 8.1 | 7.2 | 4.1 | - | - | 59 | 7.2 | 7.0 | 6.6 | 2.8 | - | - | | |
| 59 | 9.4 | 7.9 | 7.2 | 4.1 | 3.3 | - | 65 | 7.0 | 6.8 | 6.4 | 2.8 | 2.6 | - | | |
| 65 | 9.0 | 7.7 | 7.0 | 3.9 | 3.3 | - | 72 | 6.8 | 6.6 | 6.1 | 2.6 | 2.6 | - | | |
| 72 | 8.3 | 7.5 | 6.8 | 3.5 | 3.3 | - | 79 | 6.3 | 6.1 | 5.5 | 2.6 | 2.6 | 2.4 | | |
| 79 | 7.4 | 7.0 | 6.6 | 3.5 | 3.3 | 2.8 | 85 | 5.7 | 5.7 | 5.3 | 2.4 | 2.6 | 2.4 | | |
| 85 | 5.8 | 6.8 | 6.4 | 3.3 | 3.3 | 2.6 | 92 | 4.3 | 5.2 | 5.0 | 2.4 | 2.4 | 2.4 | | |
| 92 | 4.6 | 5.4 | 6.1 | 3.3 | 3.3 | 2.6 | 98 | 3.3 | 4.2 | 4.8 | 2.4 | 2.4 | 2.4 | | |
| 98 | 3.3 | 4.4 | 4.9 | 3.1 | 3.1 | 2.6 | 105 | 2.4 | 3.0 | 3.5 | 2.4 | 2.4 | 2.4 | | |
| 105 | 2.4 | 3.0 | 3.5 | 3.0 | 2.8 | 2.6 | 111 | 1.6 | 2.2 | 2.7 | 2.2 | 2.4 | 2.4 | | |
| 111 | 1.8 | 2.4 | 2.7 | 2.4 | 2.6 | 2.6 | 118 | - | 1.5 | 1.9 | 1.5 | 2.2 | 2.2 | | |
| 118 | - | 1.5 | 1.9 | 1.7 | 2.6 | 2.6 | 124 | - | - | - | - | 2.0 | 2.2 | | |
| 124 | - | - | - | - | 2.0 | 2.4 | 131 | - | - | - | - | - | 1.9 | | |
| 131 | - | - | - | - | 1.5 | 2.2 | 138 | - | - | - | - | - | - | | |
| 138 | - | - | - | - | - | 1.5 | 144 | - | - | - | - | - | - | | |

Lifting capacities main boom extension

11,000 lb   25'3" x 23' 360° 85 %

| 151.3 ft Main boom | | | | | | |
|--------------------|-----------|-----|-----|---------|-----|-----|
| Radius ft | Extension | | | | | |
| | 30.2 ft | | | 57.7 ft | | |
| | 0° | 20° | 40° | 0° | 20° | 40° |
| | 1,000 lb | | | | | |
| 33 | 9.4 | - | - | - | - | - |
| 39 | 9.4 | - | - | 4.1 | - | - |
| 46 | 9.4 | 8.1 | - | 4.1 | - | - |
| 52 | 9.4 | 8.1 | 7.2 | 4.1 | - | - |
| 59 | 9.4 | 7.9 | 7.2 | 4.1 | 3.3 | - |
| 65 | 9.0 | 7.7 | 7.0 | 3.9 | 3.3 | - |
| 72 | 7.5 | 7.5 | 6.8 | 3.5 | 3.3 | - |
| 79 | 5.4 | 6.7 | 6.5 | 3.5 | 3.3 | 2.8 |
| 85 | 4.4 | 5.3 | 6.1 | 3.3 | 3.3 | 2.6 |
| 92 | 3.0 | 4.1 | 4.6 | 3.2 | 3.3 | 2.6 |
| 98 | 2.0 | 2.9 | 3.3 | 2.6 | 3.1 | 2.6 |
| 105 | - | 1.9 | 2.4 | 1.9 | 2.8 | 2.6 |
| 111 | - | - | 1.6 | - | 2.4 | 2.6 |
| 118 | - | - | - | - | 1.7 | 2.6 |
| 124 | - | - | - | - | - | 2.0 |

| 164.0 ft Main boom | | | | | | |
|--------------------|-----------|-----|-----|---------|-----|-----|
| Radius ft | Extension | | | | | |
| | 30.2 ft | | | 57.7 ft | | |
| | 0° | 20° | 40° | 0° | 20° | 40° |
| | 1,000 lb | | | | | |
| 39 | 7.2 | - | - | - | - | - |
| 46 | 7.2 | 7.2 | - | 2.8 | - | - |
| 52 | 7.2 | 7.2 | 6.6 | 2.8 | - | - |
| 59 | 7.2 | 7.0 | 6.6 | 2.8 | - | - |
| 65 | 7.0 | 6.8 | 6.4 | 2.8 | 2.6 | - |
| 72 | 6.8 | 6.6 | 6.1 | 2.6 | 2.6 | - |
| 79 | 5.2 | 6.1 | 5.5 | 2.6 | 2.6 | 2.4 |
| 85 | 4.2 | 5.1 | 5.3 | 2.4 | 2.6 | 2.4 |
| 92 | 2.8 | 3.9 | 4.6 | 2.4 | 2.4 | 2.4 |
| 98 | 2.0 | 2.9 | 3.3 | 2.4 | 2.4 | 2.4 |
| 105 | - | 1.9 | 2.4 | 1.5 | 2.4 | 2.4 |
| 111 | - | - | 1.6 | - | 2.2 | 2.4 |
| 118 | - | - | - | - | 1.5 | 2.2 |
| 124 | - | - | - | - | - | 1.8 |
| 131 | - | - | - | - | - | - |

Working ranges main boom extension

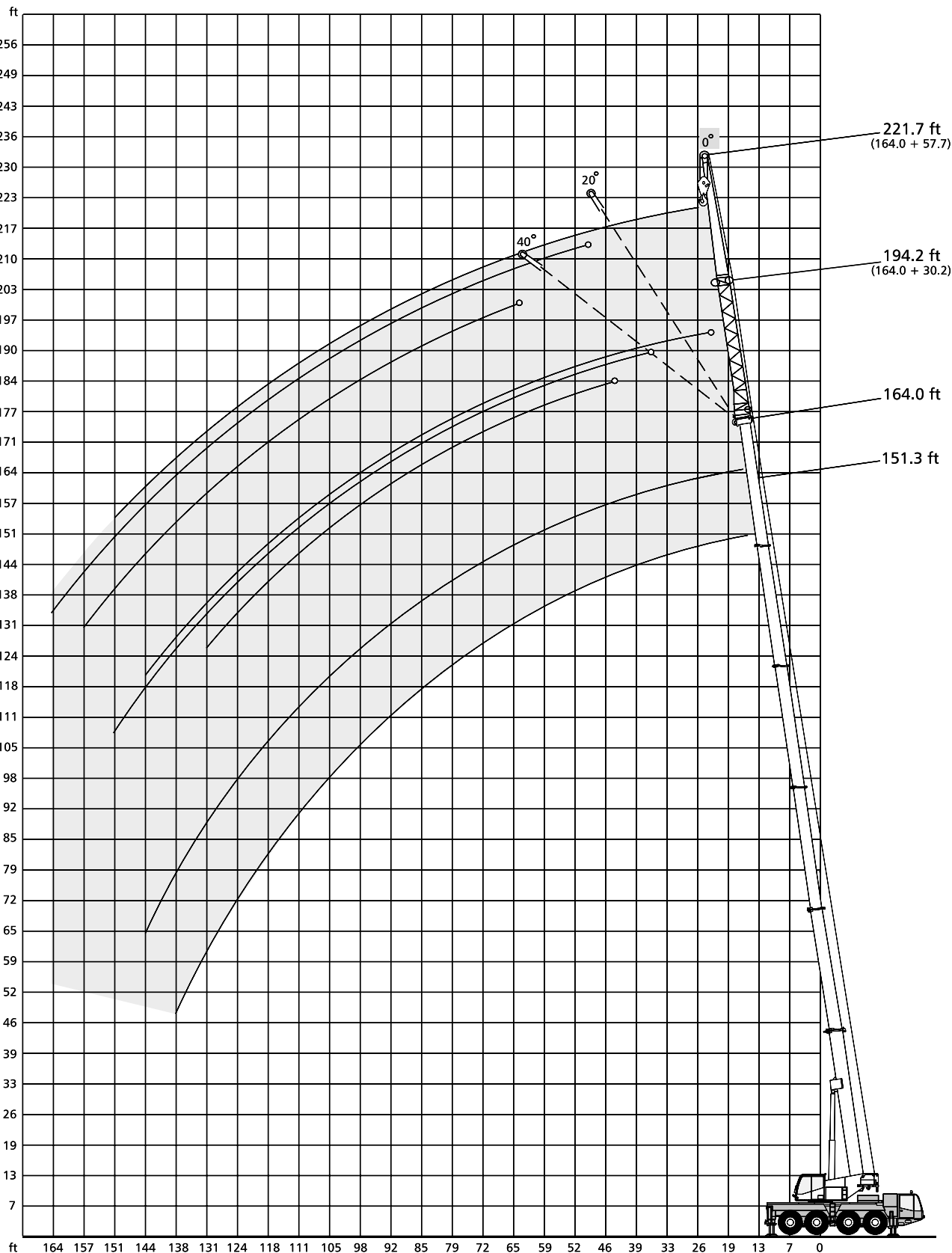

Notes to lifting capacity

Lifting capacities do not exceed 85% of tipping load.

Weight of hook blocks and slings is part of the load, and is to be deducted from the capacity ratings.

Crane operation is permissible up to a

wind pressure of 1.25 lb/ft²

wind speed of 32 ft

Consult operation manual for further details.

Note: Data published herein is intended as a guide only and shall not be construed to warrant applicability for lifting purposes. Crane operation is subject to the computer charts and operation manual both supplied with the crane.

Technical description

Carrier

| | |
|-----------------------------|--|
| Drive / steering | 8 x 6 x 6. |
| Frame | Monobox main frame with outrigger boxes integral, of high-strength fine-grain structural steel. |
| Outriggers | Four hydraulically telescoping outrigger beams with hydraulic jack legs. |
| Engine | Water-cooled 6 cylinder DaimlerChrysler engine OM 501 LA, output to DIN: 315 kW (428 hp) at 1800 ¹ /min, max. torque 2000 Nm at 1080 ¹ /min, certified in compliance with EURO MOT 2, EPA 2, CARB, stainless steel exhaust system with spark arrestor. Tank capacity: 400 l. |
| Transmission | Allison automatic transmission, transfer case with off-road range. |
| Axles | 1st: steering. 2nd: steering. 3rd: rigid, non-steering, 4th: steering. Axles 1, 2 and 4 with planetary hubs. Differential lock-out control on 2nd axle: longitudinal and transverse. 1st and 4th axle: transverse. |
| Suspension | Hydropneumatic suspension, all axles hydraulically blockable. |
| Wheels and tires | 8 x 14.00 R 25 on 11.25-25 rims; tubeless road-tread tires. All axles single-wheeled. |
| Steering | Dual-circuit semiblock mechanical steering with hydraulic booster. |
| Brakes | Service brake: dual-line air system with ABS, acting on all wheels. Parking brake: spring-loaded type. Sustained action brake: engine exhaust brake and constant decompression valve. |
| Electrical equipment | 24 V. |
| 2-man driver's cab | Rubber-mounted steel cab with safety glass, carrier controls, air-sprung and heated driver's and passenger seat with integrated seat belts, height and tilt adjustable steering wheel, electric window winders, electrically adjustable and heated outside mirrors, cruise control, radio with CD-player, rotary beacon. |

Superstructure

| | |
|--------------------------------|--|
| Hydraulic system | Driven off carrier engine at low revs, 1 variable-displacement axial piston pump and separate fixed-displacement pump for 4 simultaneous, independent working movements. |
| Hoist | Fixed-displacement axial-piston motor, hoist drum with planetary reduction integral and spring-applied holding brake. |
| Slew unit | Hydraulic motor with planetary reduction, foot-pedal brake and spring-applied holding brake. |
| Derricking unit | 1 differential cylinder with pilot-controlled lowering brake valve. |
| Crane cab | Spacious all-steel comfortable cab with sliding door and large hinged windscreen, roof window with armoured glass, controls and instrumentation for all crane movements, working lights, self-contained hot water heater with timer, thermostat-controlled, windscreen washer and wiper with intermittent control, cab tiltable up to 20°. |
| Main boom | Boom base and 5 telescopic sections of fine-grain structural steel, telescoping with partial load, buckling-resistant Demag ovaloid design. |
| Counterweight | 17,600 lb in sections of 11,250 lb, 3,750 lb and 2,650 lb (15,000 lb fitted on superstructure, 2,650 lb hydraulically stowed on carrier deck). |
| Top steer facility | Included as standard. |
| Safety devices | Electronic safe load indicator with digital read-out for hook load, rated load, boom length, boom angle, load radius, analog display to indicate the capacity utilization. Limit switches on hoist and lowering motions, pressure-relief and safety holding valves. |
| Hydraulic servo control | Hydraulic pilot control through self-centering control levers. |

Optional equipment

| | |
|--|---|
| Drive / steering | 8 x 8 x 8. |
| Tires | Optional 16.00 R 25, 17.5 R 25 or 20.5 R 25. |
| Telma brake | |
| Tow coupling | D-value 26,460 lb, air brake hookup. |
| Hoist II | Fixed displacement axial-piston motor, hoist drum with planetary reduction integral and spring-applied holding brake. Hoist II avoids re-reeving of hoist line when using the optional jib. |
| Main boom extension | 1- or 2-part folding jib, 30.2 ft or 57.7 ft. 0°, 20° and 40° offset. |
| Additional counterweight | 22,050 lb, integrated into standard counterweight, installed hydraulically by the crane itself. |
| Heavy-lift attachment | Additional sheaves on boom head for duties over 132,000 lb. |
| Heavy-lift runner | 3.3 ft long, 3-sheave, for workshop applications. Stowed on carrier during transit. |
| Outrigger loading indicator | |
| Limitation of working range | |
| Radio with CD-player in upper cab | |
| Stowing point for hook block | For 1 and 3-sheave hook blocks or for 5-sheave hook block, for single line hook block. |
| Tackle box on the rear of the carrier | |

Overview of standard duty charts

 25'3" x 23'

 25'3" x 14'9"

Main boom

| Main boom |  | | |
|-----------|---|-----------|-----------|
| | 11,000 lb | 17,600 lb | 39,700 lb |
| 35.8 ft | x | x | x |
| 52.8 ft | x | x | x |
| 70.2 ft | x | x | x |
| 82.0 ft | x | x | x |
| 102.8 ft | x | x | x |
| 121.9 ft | x | x | x |
| 138.9 ft | x | x | x |
| 151.3 ft | x | x | x |
| 164.0 ft | x | x | x |

| Main boom |  | | |
|-----------|---|-----------|-----------|
| | 11,000 lb | 17,600 lb | 39,700 lb |
| 35.8 ft | x | x | x |
| 52.8 ft | x | x | x |
| 70.2 ft | x | x | x |
| 82.0 ft | x | x | x |
| 102.8 ft | x | x | x |
| 121.9 ft | x | x | x |
| 138.9 ft | x | x | x |
| 151.3 ft | x | x | x |
| 164.0 ft | x | x | x |

Main boom extension

| Main boom | Extension 0° / 20° / 40° |  | | |
|-----------|-----------------------------|---|-----------|-----------|
| | | 11,000 lb | 17,600 lb | 39,700 lb |
| 151.3 ft | 30.2 ft | x | x | x |
| | 57.7 ft | x | x | x |
| 164.0 ft | 30.2 ft | x | x | x |
| | 57.7 ft | x | x | x |

| Main boom | Extension 0° / 20° / 40° |  | | |
|-----------|-----------------------------|---|-----------|-----------|
| | | 11,000 lb | 17,600 lb | 39,700 lb |
| 151.3 ft | 30.2 ft | - | x | x |
| | 57.7 ft | - | x | x |
| 164.0 ft | 30.2 ft | - | x | x |
| | 57.7 ft | - | x | x |

Specifications

Axle loads

Basic machine, main boom, 30.2 ft main boom extension, single line hook, 17,600 lb counterweight, tires 14.00 R 25

Axles 4 x 26,460 lb
Total 105,840 lb

Working speeds (infinitely variable)

| Mechanisms | Normal speed | High speed | Max. permissible line pull ¹⁾ | Length of hoist rope |
|-------------------|--------------|--------------|--|----------------------|
| Hoist I | 174 ft / min | 361 ft / min | 13,200 lb | 689 ft |
| Hoist II | 174 ft / min | 361 ft / min | 13,200 lb | 689 ft |
| Slewing | | | | max. 2 rpm |
| Telescoping speed | | | | 35.8 – 164 ft: 110 s |
| Boom elevation | | | | -1.8° – +81.5°: 63 s |

Carrier performance

Travel speed
Forward 0 to 50 mph
Reverse 0 to 7.5 mph
Gradeability in travel order max. 50%
Ground clearance 13 inches

Hook block / Single line hook

| Type | Possible load ¹⁾ | Number of sheaves | Weight | „D“ | Number of lines | Heavy-lift attachment |
|------|-----------------------------|-------------------|---------|--------|-----------------|-----------------------|
| 100* | 176,000 lb | 7 | 1650 lb | 6.6 ft | 14 | 2 add. sheaves |
| 80* | 145,000 lb | 5 | 1430 lb | 6.6 ft | 11 | 2 add. sheaves |
| 50 | 92,000 lb | 3 | 1210 lb | 5.9 ft | 7 | |
| 20 | 39,600 lb | 1 | 770 lb | 5.9 ft | 3 | |
| 6,3 | 13,200 lb | Single line hook | 374 lb | 5.6 ft | 1 | |

Remarks

* heavy-lift attachment is required, 2 add. sheaves

¹⁾ varies depending on national regulations

